

# OUTDOOR INSULATORS

*Dr. R. Raja Prabu*  
*Senior Professor / EEE*



# Introduction to Outdoor Insulators



# History

- ❑ Insulators are much older than power transmission: telegraph insulators, introduced about 1835, had reached an advanced state of evolution by 1878, whereas the first transmission line was not run before 1882.
- ❑ This short line, from Miesbach to Munich, for 1343 V DC, was designed by von Miller and Duprez, to run an artificial waterfall at the Munich Electrical Exhibition.



# History

- ❑ Both Glass and Porcelain were used before 1878 to insulate Telegraph lines.
- ❑ The electric and mechanical stresses, which telegraph insulators were required to withstand were evidently negligible in comparison with those from power – line duty.



# Necessity

- For the insulation of separate parts of electrical installations having different potentials (eg: conductors or bus-bars of different phases) it is essential to separate them from each other by a definite distance so that air will act as the main insulating medium.
- At the places of fastening, conductors or bus- bars are insulated from earthed supporting structures with the help of insulators.



# OVERVIEW



# Introduction - Insulators

- ❑ An insulator is a poor conductor.
- ❑ According to ANSI C2 document, 1997 – An Insulator is an insulating material designed to support a conductor physically and electrically separate it from another conductor or object.
- ❑ Maintains air gap
- ❑ Resists mechanical stresses.
- ❑ Resists Electrical Stresses.
- ❑ Resists Environmental Stresses.
- ❑ The primary function of outdoor insulators is to support overhead conductors, ie., mechanical support



# Introduction - Insulators

- ❑ The secondary function of outdoor insulator is to insulate the bare conductors from their supporting structures.
- ❑ The electrical requirement is derived from the probability of flashover either during lightning strikes for systems below 345kV, or during switching operations for systems above 345kV.
- ❑ Electrically isolate the conductors.
- ❑ Provides mechanical support to the system
- ❑ Factors – Operating Condition, Ease of Fabrication , Availability & Cost.
- ❑ Properties- Electrical , Mechanical , Thermal , Chemical & Visual





# Electrical Functions

- Air is the Insulator
- Outer shells/ surfaces are designed to increase leakage distance and strike distance.



# General Properties of Insulating Materials

- The different properties affecting the selection of materials are grouped as:
  - ✓ Electrical Properties
  - ✓ Mechanical Properties
  - ✓ Thermal Properties
  - ✓ Chemical Properties
  - ✓ Visual Properties



# ...Contd...Electrical characteristics

## ❖ Electrical Properties / Characteristics:

- Insulation Resistance.
  1. Volume Resistance
  2. Surface Resistance
- Dielectric strength
- Dielectric Constant
- Dielectric loss etc.



# .... Contd...- Characteristics - Electrical

- Dielectric Strength or Breakdown voltage:

The dielectric material has only some electrons in normal operating condition. When the electric strength is increased beyond a particular value, it results in breakdown. That is, the insulating properties are damaged and it finally becomes a conductor. The electrical field strength at the time of breakdown is called breakdown voltage or dielectric strength.

DIELECTRIC MATERIAL	DIELECTRIC STRENGTH(KV/MM)	DIELECTRIC CONSTANT
Air	3	1
Oil	5-20	2-5
Mica	60-230	5-9



# .... Contd...- Characteristics - Mechanical

- **Mechanical properties :**
  - Tensile strength
  - percentage of elongation
  - impact strength etc.
- **The major factors which affect the mechanical properties are:**
  - Temperature Rise
  - Climatic Effects
  - Viscosity
  - Porosity
  - Solubility
  - Machinability & Mouldability



- **Thermal characteristics :**
  - Thermal transition temperatures
  - Thermal stability
  - Mechanical stability etc.



# .... Contd... - Characteristics - Thermal

- One of the major functions of insulation is heat transfer and the various factors influencing the same are:
  - Melting Point
  - Flash point
  - Volatility
  - Thermal Conductivity
  - Thermal Conductivity
  - Thermal Expansion
  - Heat Resistance
  - Operating temperatures
  - Effect of temperature increase



- **Chemical Properties / Characteristics:**

The various factors which influence the same

- Chemical Resistance.

- Hygroscopicity

- Effect of contact with other materials

- Ageing.





- **Chemical Properties / Characteristics:**

It helps in customers' selection of the insulating material. Some factors are

- Appearance.
- Colour
- Crystallinity



# IMPORTANT DEFENITIONS



# Some Definitions

## ❑ External Insulation:

The air insulation and the exposed surfaces of insulators, which are both subjected to dielectric stresses and to the effects of atmospheric and other external conditions such as contamination, humidity etc.,.

## ❑ Internal Insulation:

Internal insulation comprises the internal elements of the insulator which are protected from the effects of atmospheric and other external conditions such as contamination, humidity etc.,.



# Some Definitions

- Self Restoring Insulation:

Insulation that completely recovers its insulating properties after a disruptive discharge caused by the application of a test voltage. Insulation of this kind is generally, but not necessarily, external insulation.

- Non - Self Restoring Insulation:

Insulation that loses its insulating properties or does not recover them completely, after a disruptive discharge caused by the application of a test voltage. Insulation of this kind is generally, but not necessarily, internal insulation.



# Some Definitions

- Puncture:

Term used when a disruptive discharge occurs through a solid dielectric. This usually produces permanent loss of dielectric strength.

- Flashover:

A disruptive discharge through air or over the surface of solid insulation, between parts of different potential or polarity produced by the application of voltage wherein the breakdown path becomes sufficiently ionized to maintain an electric arc.



# Some Definitions

- Basic Lightning Impulse Insulation level (BIL):

The crest value of a standard lightning impulse for which the insulation exhibits a 90% probability of withstand ( 10% probability of failure) under specified conditions applicable for self – restoring insulation.

- Basic switching Impulse Insulation Level (BSL):

The crest value of a standard switching impulse for which the insulation exhibits a 90% probability of withstand ( 10% probability of failure) under specified conditions applicable for self – restoring insulation.



# Some Definitions

- Dry – Arc or strike distance:

The shortest distance through the surrounding medium between terminal electrodes, or the sum of the distances between intermediate electrodes, whichever is shorter.

- Connection Length:

The shortest distance between the conductor and the support structure. This includes the strike distance plus the hardware dimensions.



# Schematic of porcelain/glass insulator showing various dimensions

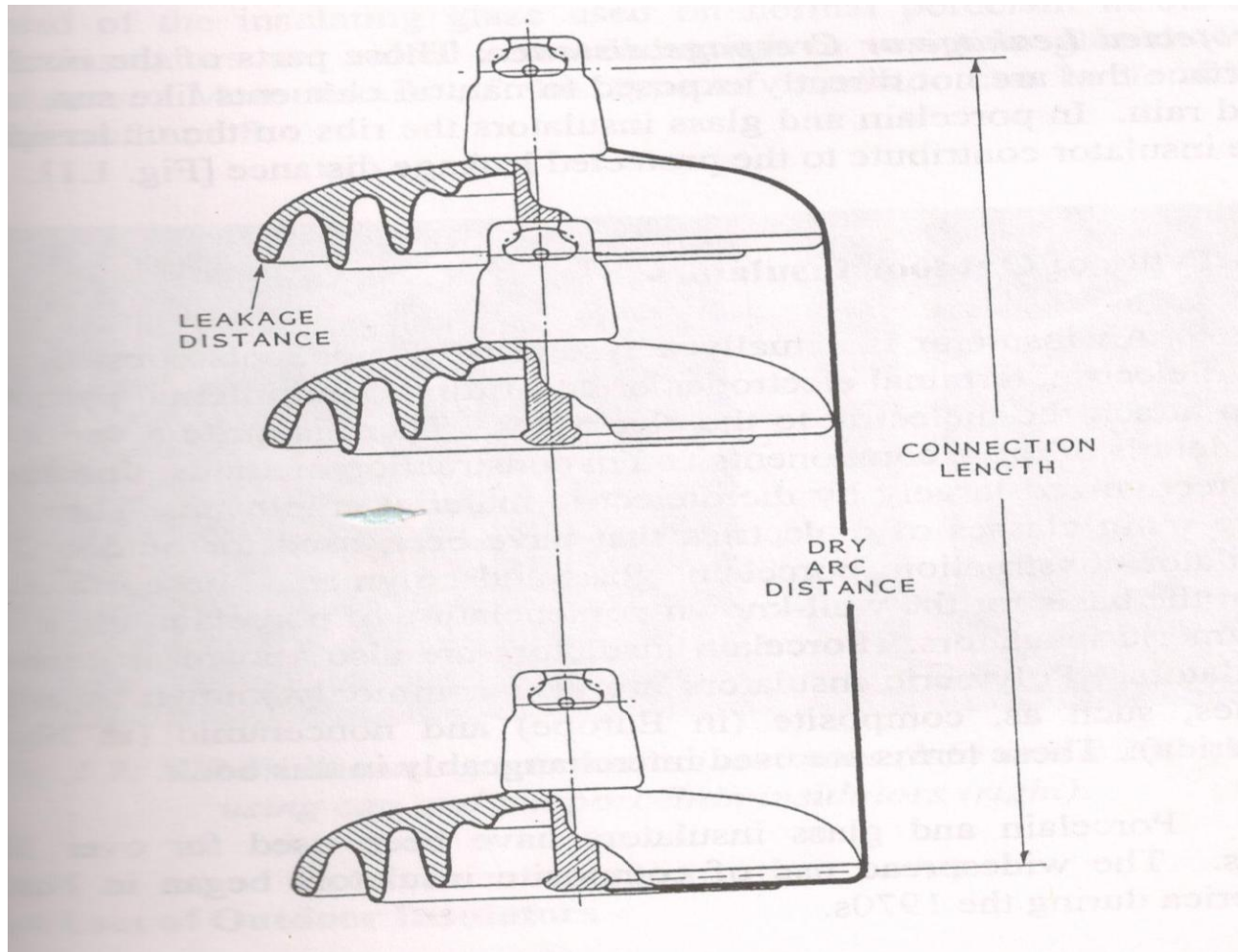



# Some Definitions

- Leakage or Creepage distance:

The sum of the shortest distances measured along the insulating surfaces between the conductive parts.

- Protected Leakage:

Those parts of the insulator surface that are not directly exposed to natural elements like sun, wind and rain. In porcelain and glass insulators the ribs on the underside of the insulator contribute to the protected leakage distance.



# TYPES OF INSULATORS



# Qualities of an Ideal Insulator

- ❖ An ideal insulating material should possess:
  - ✓ Dielectric strength as good as that of Mica??
  - ✓ Volume and surface resistivity equal to that of sulphur
  - ✓ Mechanical strength as good as that of steel
  - ✓ Crushing resistance as good as that of granite
  - ✓ Ease of machining as good as that of wood.



# Qualities of an Ideal Insulator

- ✓ Fire proofing qualities as good as that of silica
- ✓ Chemical inertness equal to that of platinum
- ✓ Surface finish like that of ebonite
- ✓ Water proofing quality as good as that of Paraffin wax.



# General Classification of Insulators

- ❖ There are three broad categories of the insulating materials viz.,
  - ✓ Solids
  - ✓ Liquids
  - ✓ Gases



# Classification of Insulating Materials

## - I. Insulating Gases:

- ❖ Simple gases eg.,. Air and nitrogen are commonly in use as insulators.
- ❖ Electronegative gases such as  $SF_6$  are in use, now – a – days
- ❖ Simple Gases
  - ✓ Air
  - ✓ Nitrogen
  - ✓ Hydrogen
  - ✓ Helium etc.,.



# Classification of Insulating Materials

## - I. Insulating Gases:

### ❖ Hydrocarbon Gases

- ✓ CO<sub>2</sub>
- ✓ SO<sub>2</sub> etc.,.

### ❖ Oxide Gases

- ✓ Methane
- ✓ Ethane
- ✓ Propane etc.,.



# Classification of Insulating Materials

## - I. Insulating Gases:

### ❖ Electronegative Gases

✓ Freon

✓ SF<sub>6</sub> etc.,.

❖ The selection of gaseous insulator needs complete knowledge of its dielectric behaviour, in the range of temperatures and pressures within which the insulating gas is expected to work.





# Classification of Insulating Materials

## - II. Insulating Liquids:

❖ Insulating liquids fulfills the following functions:

1. Provides Insulation.
2. Improves insulating properties of materials by eliminating air and other gases.
3. They offer good heat dissipation media.
4. Extinguishes arcs in certain applications like circuit breakers.



# Classification of Insulating Materials

## - II. Insulating Liquids:

- ❖ Types:
  - ✓ Vegetable Oils
  - ✓ Mineral Oils
  - ✓ Synthetic Oils
  
- ❖ Main features:
  - ✓ Oxidation
  - ✓ Moisture
  - ✓ Temperature
  
- ❖ Miscellaneous Insulating Liquids:
  - ✓ Fluorinated Liquids
  - ✓ Silicon Liquids



# TYPES OF OUTDOOR INSULATORS



# Types - Based on Materials

- Ceramic Insulators



- Glass Insulators



- Polymeric Insulators



# Porcelain Insulators

- ❖ Ceramic dielectric for electrical strength
- ❖ Metal cap and pin electrodes
- ❖ Cement or Bitumen for bonding electrodes to dielectric
- ❖ More thermal energy is required for manufacturing
- ❖ Porcelain wet out easily



# Porcelain Insulators



## Insulators



# Porcelain Insulators

- ❖ The porcelain is aluminium silicate.
- ❖ The aluminium silicate is mixed with plastic kaolin, feldspar and quartz to obtain final hard and glazed porcelain insulator material.
- ❖ The surface of the insulator should be glazed enough so that water should not be traced on it.



# Porcelain Insulators

- ❖ Porcelain also should be free from porosity since porosity is the main cause of deterioration of its dielectric property.
- ❖ It must also be free from any impurity and air bubble inside the material which may affect the insulator properties.





# PROPERTIES

Specific Gravity: 2.35-5 g/cc.

Operating Temperature: 1200 °C

Dielectric constant: 5-7

Resistivity:  $10^{11-14}$  ohm-m

Low-Hydrophobicity

High chemical Resistance

High tensile strength.



# Glass Insulators



# Glass Insulators

- ❖ Annealed tough glass is used for insulating purpose
- ❖ It has very high dielectric strength compared to porcelain.
- ❖ Its resistivity is also very high.
- ❖ It has low coefficient of thermal expansion.
- ❖ It has higher tensile strength compared to porcelain insulator.



# Glass Insulators

- ❖ As it is transparent in nature, it is not heated up in sunlight as porcelain.
- ❖ The impurities and air bubble can be easily detected inside the glass insulator body because of its transparency.
- ❖ Glass has very long service life as because mechanical and electrical properties of glass do not get affected by ageing.



# Glass Insulators

- ❖ Moisture can easily condense over glass surface and hence air dust will be deposited on the wet glass surface which will provide path to the leakage current of the system.
- ❖ For higher voltage glass cannot be cast in irregular shapes since due to irregular cooling internal strains are caused.



# Glass Insulators

PROPERTY	VALUE(APPROXIMATE)
Dielectric Strength	140 KV / cm
Compressive Strength	16,000 Kg / cm <sup>2</sup>
Tensile Strength	35,000 Kg / cm <sup>2</sup>



# Composite Insulators



# Composite / Polymeric Insulators

## ❖ CORE

The core is the internal insulating part of a composite insulator. It is intended to carry the mechanical load. It consists mainly of glass fibres positioned in a resin matrix so as to achieve maximum tensile strength.

## ❖ HOUSING

The housing is external to the core and protects it from the weather. It may be equipped with weather sheds. Some designs of composite insulators employ a sheath made of insulating material between the weathersheds and the core. This sheath is part of the housing.





# Composite / Polymeric Insulators

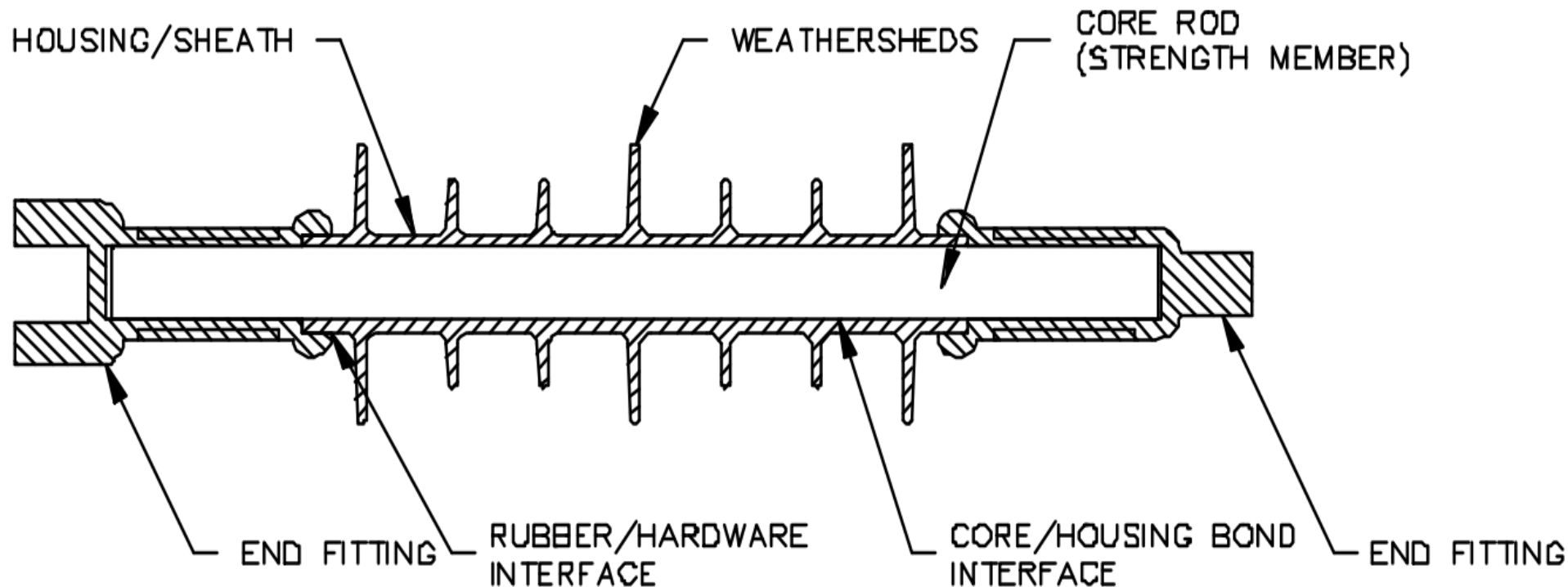

# Composite / Polymeric Insulators

## ❖ WEATHERSHEDS

- Weathersheds are insulating parts, projecting from the housing or sheath, intended to increase the leakage distance and to provide an interrupted path for water drainage.
- Basic polymer shed materials used are silicone rubber, EPM, EPDM, CE, and polytetrafluorethylene (PTFE or Teflon). To obtain desired electrical and mechanical properties these basic material are combined with various fillers, including aluminium trihydrate.



# Composite / Polymeric Insulators

## ❖ END FITTING

End fitting transmit the mechanical load to the core. They are usually made out of metal.

## ❖ COUPLING ZONE

The coupling zone is the part of the end fitting that transmits the load to the line, to the tower, or to another insulator. It does not include the interface between the core and the fitting.



# Composite / Polymeric Insulators

## ❖ INTERFACE

Examples of interface in composite insulators are as follows:

- Glass fibre/impregnating resin
- Filler/polymer
- Core/housing
- Housing/weather sheds
- Housing/end fitting
- Core/end fittings.



# Composite / Polymeric Insulators

## ADVANTAGES

- ❑ It is very light weight compared to porcelain and glass insulator
- ❑ As the composite insulator is flexible the chance of breakage becomes minimal
- ❑ Because of lighter in weight and smaller in size, this insulator has lower installation cost.
- ❑ It has higher tensile strength compared to porcelain insulator.
- ❑ Its performance is better particularly in polluted areas.
- ❑ Due to lighter weight polymer insulator imposes lesser load to the supporting structure.
- ❑ Less cleaning is required due to hydrophobic nature of the insulator.



# Composite / Polymeric Insulators

## DISADVANTAGES

- ❑ Moisture may enter in the core if there is any unwanted gap between core and weather sheds. This may cause electrical failure of the insulator.
- ❑ Over crimping in end fittings may result to cracks in the core which leads to mechanical failure of polymer insulator.
- ❑ Subject to bird attack by Parrots, etc.,.



# HYBRID INSULATORS

- ❖ Porcelain Rod
- ❖ Silicone Rubber housing

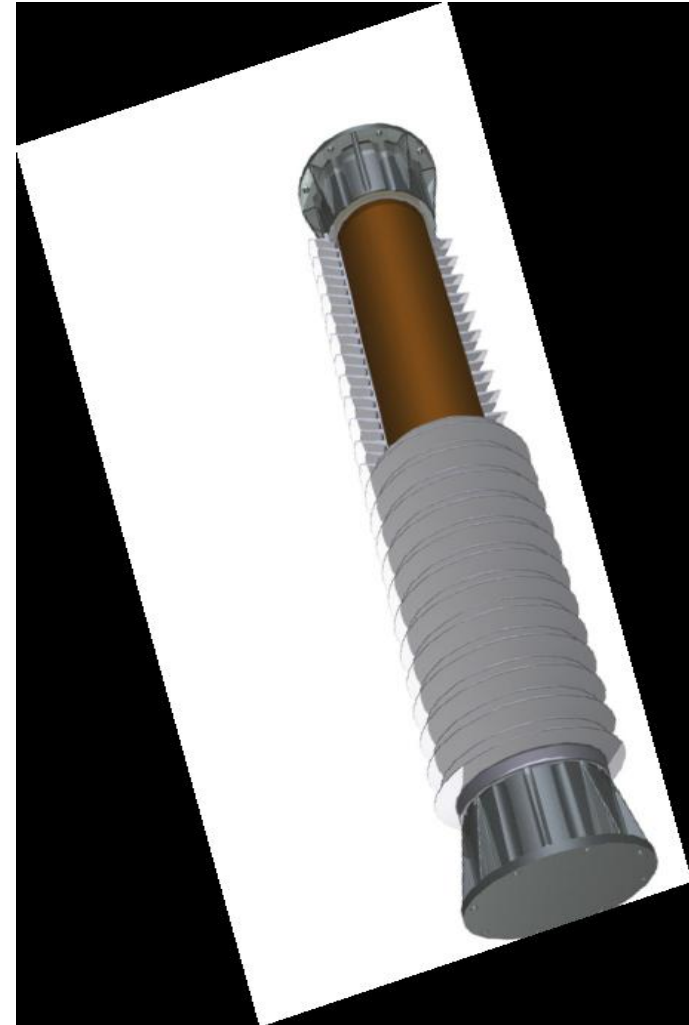

# HYBRID INSULATORS – PPC Insulators





# Polymeric Insulators

- Light weight(10% of porcelain)
- High strength to weight ratio
- Less Breakage
- Easy Erection and handling
- Reduced Maintenance
- Better Pollution Performance.
- Good dielectric properties
- Easy Emergency Installations
- Vandal resistant



Note: 40% of recently installed insulators in U.S. are Non ceramic



# Polymeric Insulators

- ❑ Light weight – Lower construction and transportation costs.
- ❑ **Vandalism Resistance – Less Gunshot damage**
- ❑ High Strength to Weight Ratio – Longer Spans/ new tower design.
- ❑ **Improved transmission line aesthetics**
- ❑ Un-explosive housing – Improved safety of the working people in the station and for the installation equipment.



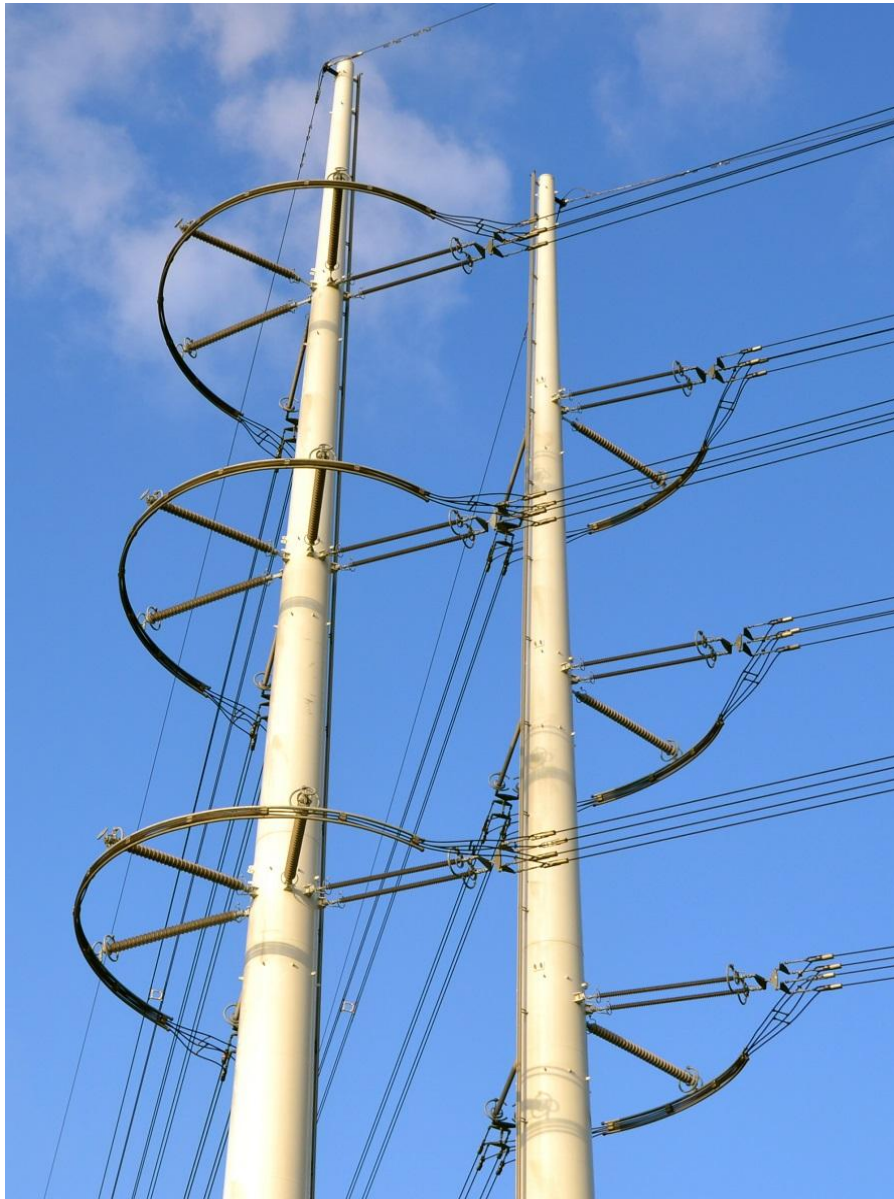



# Polymeric Insulators



- ❖ Solved several problems, created new ones (e.g., Ageing, brittle fracture, chalking and hardening of the shed)
- ❖ Reduction of beneficial properties with respect to time
- ❖ No single polymer material is universally superior
- ❖ Relatively new
- ❖ Expected life time & long term reliability are not known



# Types – Based on Function

There are three types of insulators for overhead lines.

- ❑ Pin type Insulators
- ❑ Suspension type Insulators
- ❑ Strain type Insulators



# Pin Insulators

- ❖ For the insulation of low voltage lines ie., up-to 1000 volts, most simple insulators called telegraph insulators (type TΦ and TC ) are used.
- ❖ The pin type insulators are normally used upto 33kV.
- ❖ In any case, it is not desirable to use beyond 50kV, as the cost increases much faster than voltage.

$$\text{Cost} \propto V^x, \quad \text{where } x > 2$$

- ❖ The insulators and its pins should be sufficiently mechanically strong to withstand the resultant force due to combined effect of the weight of the conductors, wind pressure and Ice loading if any.



# Pin Insulators



Pin type insulator



# Pin Insulators

- ❖ Beyond 33kV, replacement of pin insulators are expensive.
- ❖ They are not used beyond 33kV, because of
  - ✓ bulk size,
  - ✓ Less reliability due to large bending forces acting on them.





# Pin Insulators

- ❖ Pin insulator consists of single or multiple shells adapted to be mounted on a spindle to be fixed to the cross arm of the supporting structure.
- ❖ Multiple shells are provided in order to obtain sufficient length of leakage path so that the flash overvoltage between the power conductor and the pin of the insulator is increased.
- ❖ The design is such that when the upper most shell is wet due to rain the lower shells are dry and provide sufficient leakage distance.



# Pin Insulators

Fig:

PIN INSULATOR  
FOR 6-10 KV.

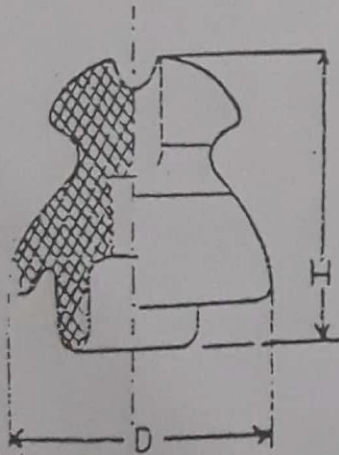
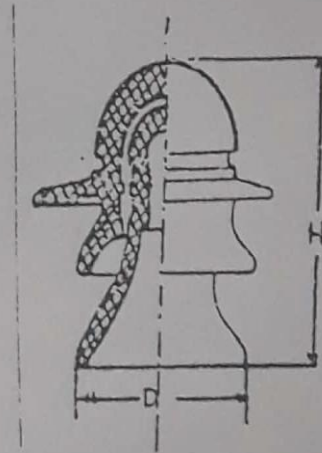
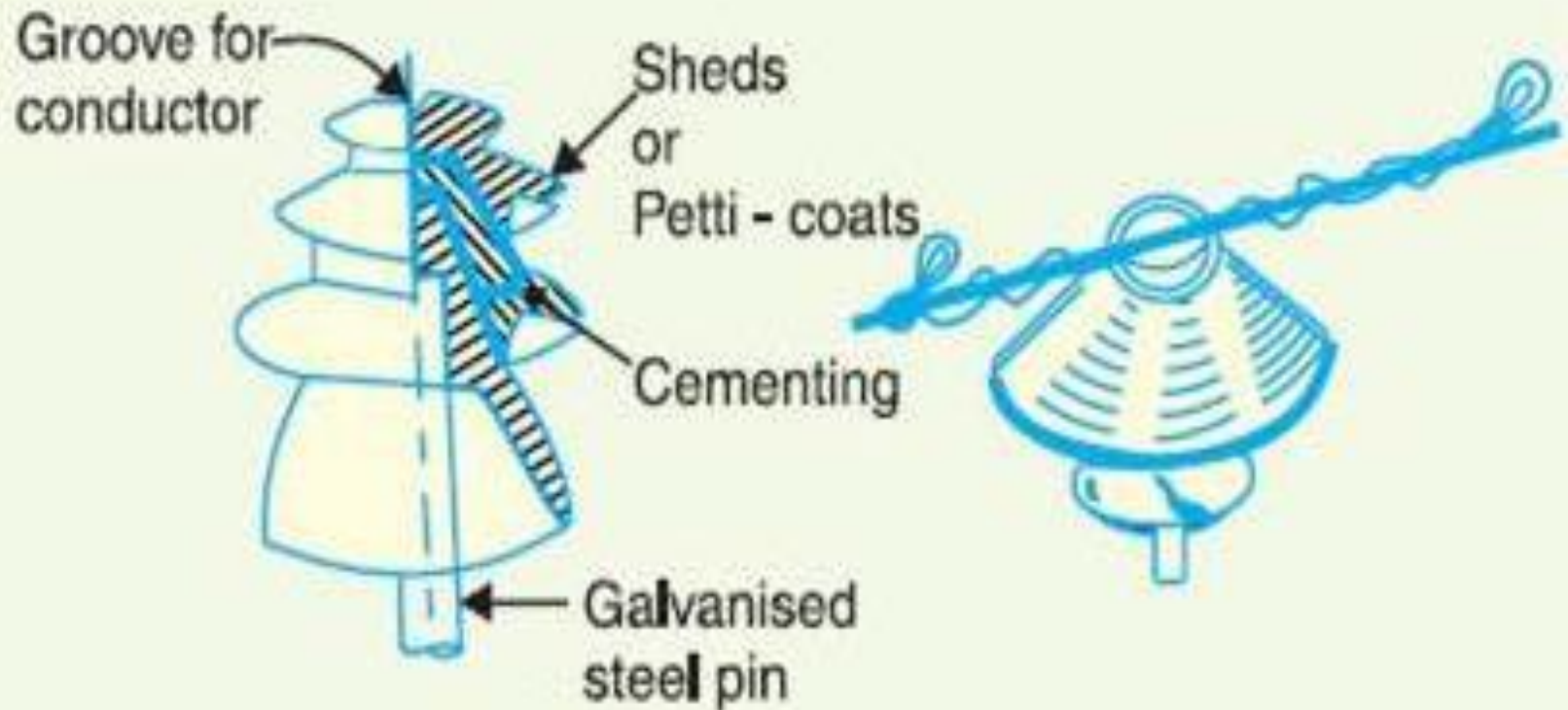

Fig:

PIN INSULATOR  
FOR 35 KV.



# Pin Insulators



# Pin Insulators

- ❖ It is to be noted that the power conductor passes through the groove at the top of the insulator and is tied to the insulator by the annealed wire of the same material as the conductor.
- ❖ It is desirable that the horizontal distance between the tip of the lower most shell should be less as compared with the vertical distance between the same lip and cross arm, otherwise in case of an arc – over the discharge will take place.



# Suspension type Insulators

- ❖ For insulation of lines beyond 33kV, Suspension insulators are used (Disc type).
- ❖ These insulators consists of one or more insulator units flexibly connected together and adapted to be hung for the cross arm of the supporting structure and to carry a power conductor at its lowest extremity. ( such composite units are known as string insulators)



# Suspension type Insulators



Suspension insulator

# Suspension type Insulators

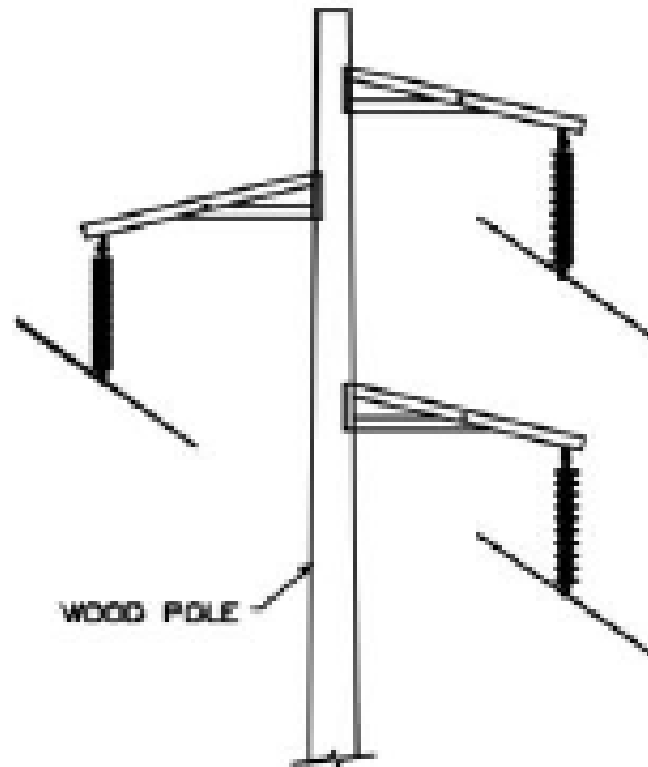

# Suspension type Insulators

- ❖ Each insulator is a single disc shaped piece of porcelain grooved on the under – surface, to increase the surface leakage path between the metal cap at the top and the metal pin at the bottom of the insulator.
- ❖ The cap at the top is recessed so that it can take the pin of another unit and in this way a string of any required no. of insulators can be built.
- ❖ The cap and the pin are secured to the insulator by means of cement.





# Suspension Insulators

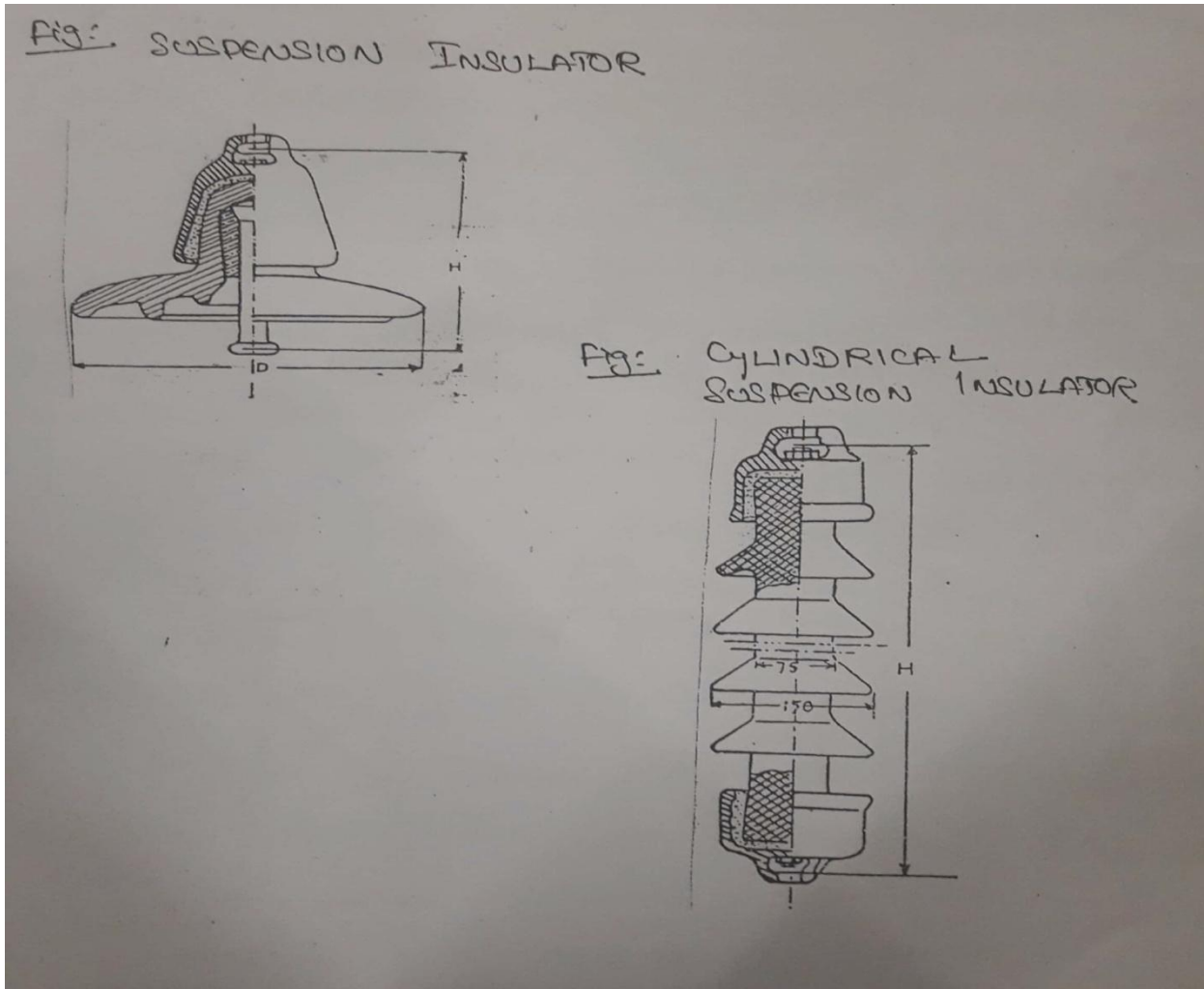

# Suspension type Insulators

- ❖ Suspension insulators being free to swing, the clearances between the power conductors and the supporting structure are more as compared to pin insulators.
- ❖ It means the length of the cross arm is more for suspension type insulators.



# A string of Suspension Insulators

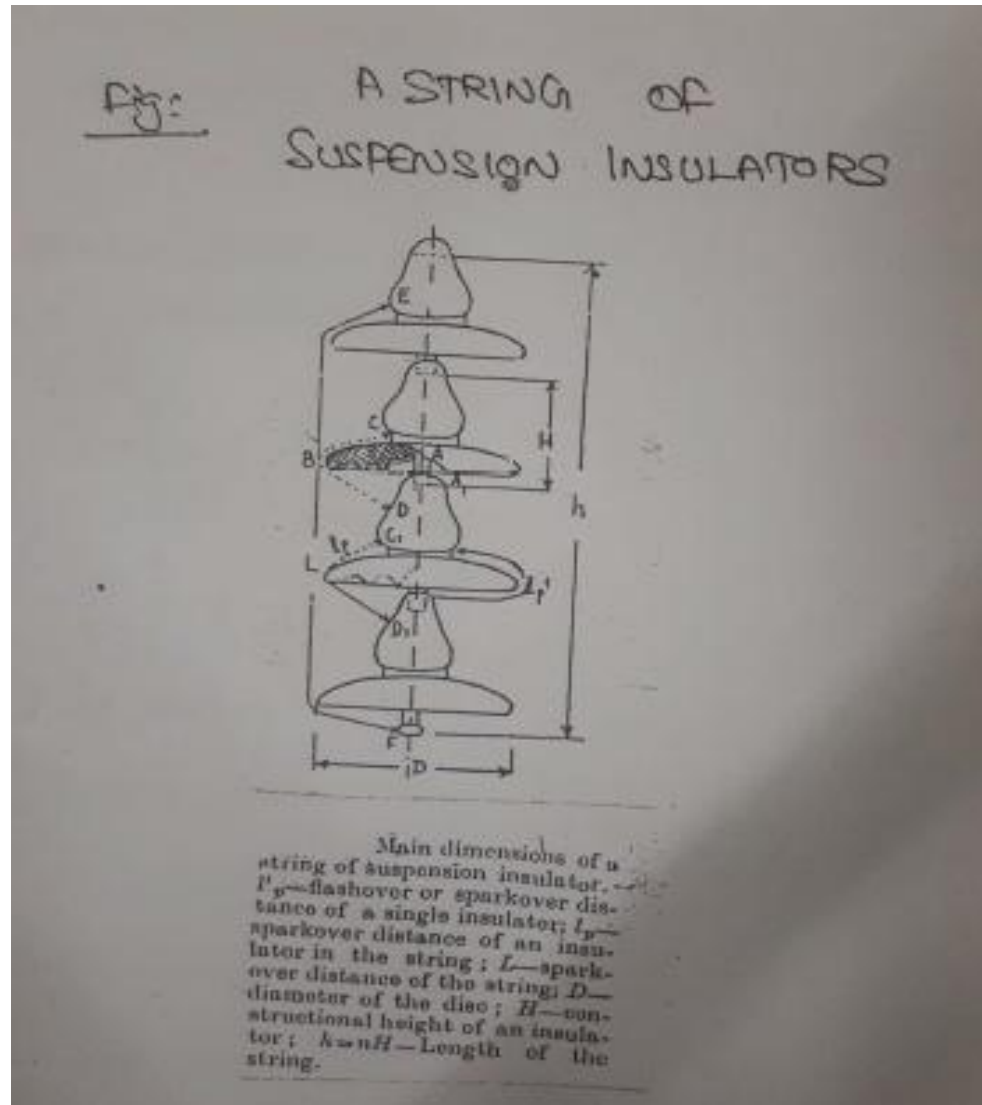

# Suspension type Insulators - Advantages

- ❖ Economical beyond 33kV.
- ❖ Each insulator is designed for 11kV and hence for any operating voltage a string of insulators can be used.
- ❖ In case of failure, only that particular unit needs replacement.



# Suspension type Insulators - Advantages

- ❖ The mechanical stresses at the point of attachment are reduced as the power conductor and the string swing together in case of wind pressure.
- ❖ The operating voltage of the existing transmission can be increased by adding suitable no. of discs in the string.



# Insulators and Supporting Structures

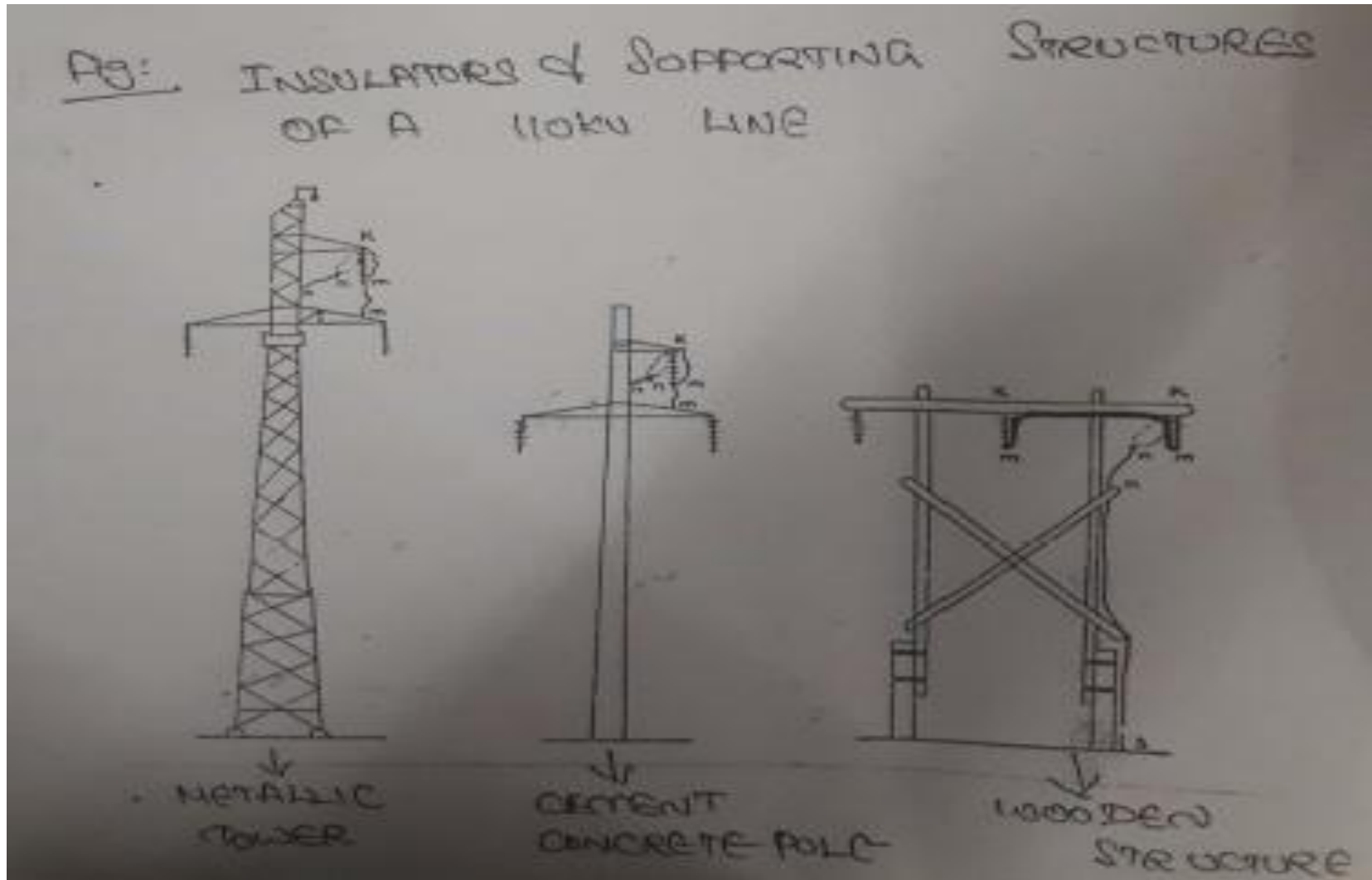

# Strain Insulators

- ❖ The strain insulators are exactly identical in shape with the suspension insulators.
- ❖ These strings are placed in the horizontal plane rather than the vertical plane as is done in the case of suspension insulators. (Discs are in vertical plane in case of string insulators)
- ❖ These are used to take the tension of the conductors at the line terminals, at angle towers, at road crossings and at junction of overhead lines with cables. That is why, they are popular as tension or strain insulators.



# Note:

- ❖ For the low voltages of the order of 11kV, shackle insulators are used.
- ❖ For higher voltages, string of insulators is used.
- ❖ Sometimes, two or three strings of insulators in parallel have been used.
- ❖ The voltage drop across the unit nearest the cross arm is minimum and it goes on increasing as we go towards the power conductors (max).
- ❖ It is obvious that the lowermost unit in a string of insulators is fully stressed or utilized.





# String Efficiency

❖ It is a measure of the Utilization of the material in the string.

❖ It is defined as:

$$\eta = \frac{\text{voltage across the string}}{n * (\text{voltage across the unit near the power conductor})}$$

Where ,

n = no. of insulators in the string.



# String Efficiency

❖ Or .....

$$\eta = \frac{\text{Spark over voltage of the string}}{n * (\text{Spark over voltage of the disc})}$$

Where ,

**n = no. of insulators in the string.**



# Station Apparatus Insulators

❖ Two major types.

✓ Post Insulators

✓ Entrance Insulators (Bushings)

❖ Post insulators serve the purpose of electrical insulation and mechanical fastening of current carrying bush-bars in distribution networks and of current carrying parts of electrical apparatus.



- ❖ Entrance Insulators are used for introducing voltage inside the metallic tanks of transformer, oil Circuit Breakers, Condensers and other apparatus and similarly for insulation of bus-bars during their passage through the walls of distribution networks.
- ❖ Apparatus type entrance insulators are often similarly called location insulators or bushings.



Major types.

- ✓ Cylindrical post Insulators
- ✓ Pin type post Insulators

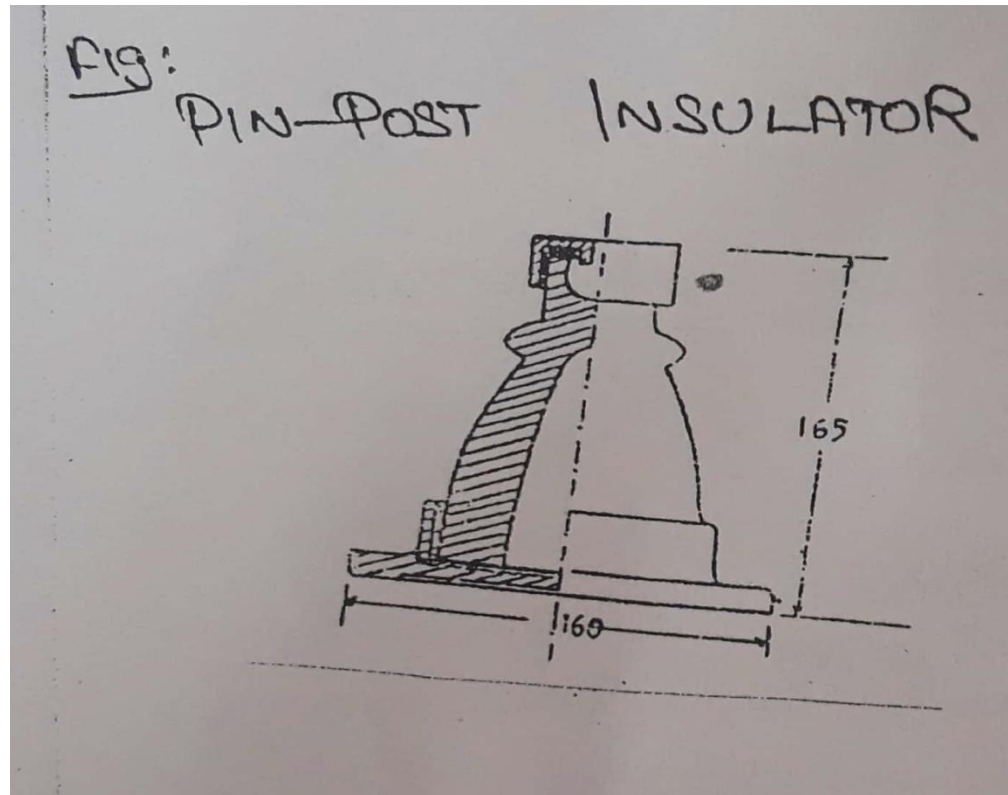

Fig:

POST INSULATOR FOR G

✓✓

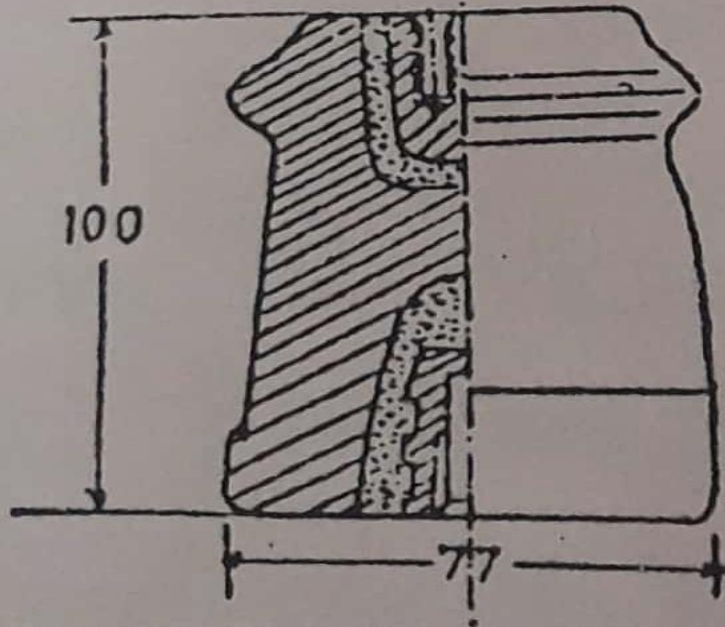

Fig:

• POST-INSULATOR FOR 35 kV

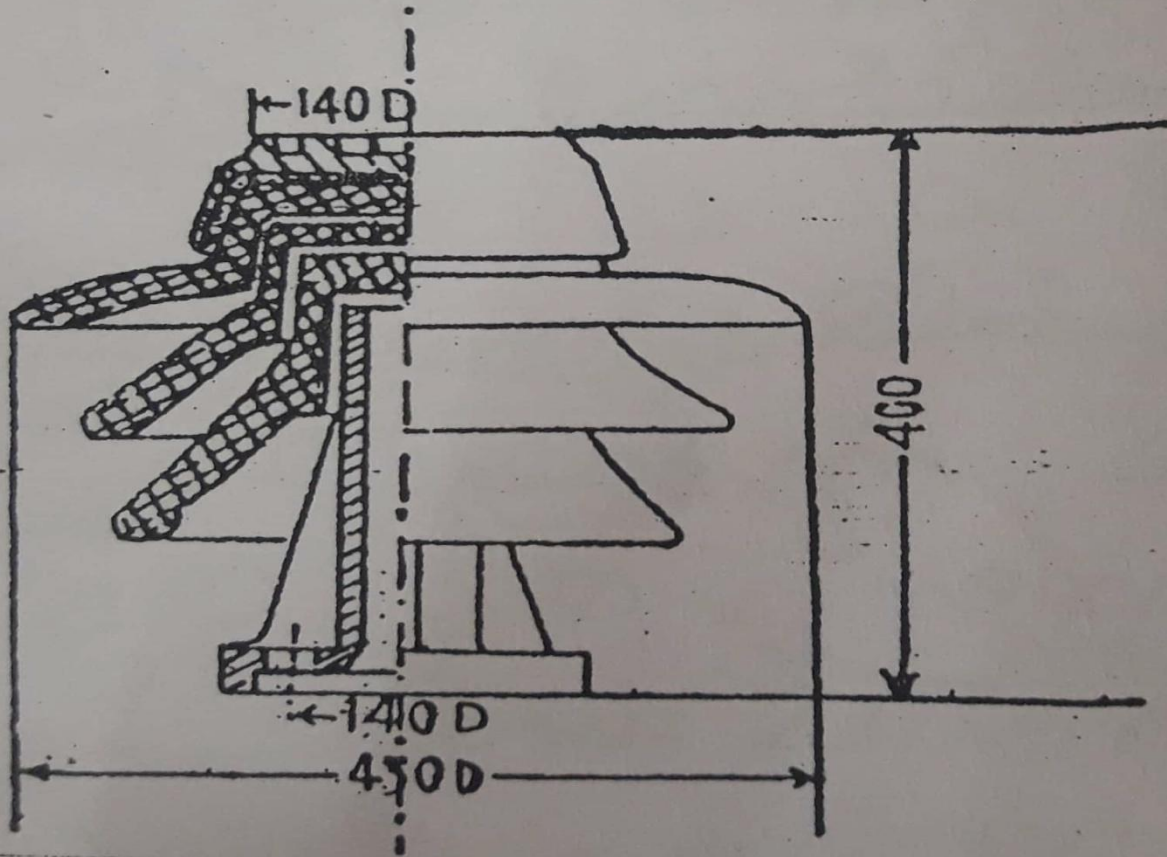
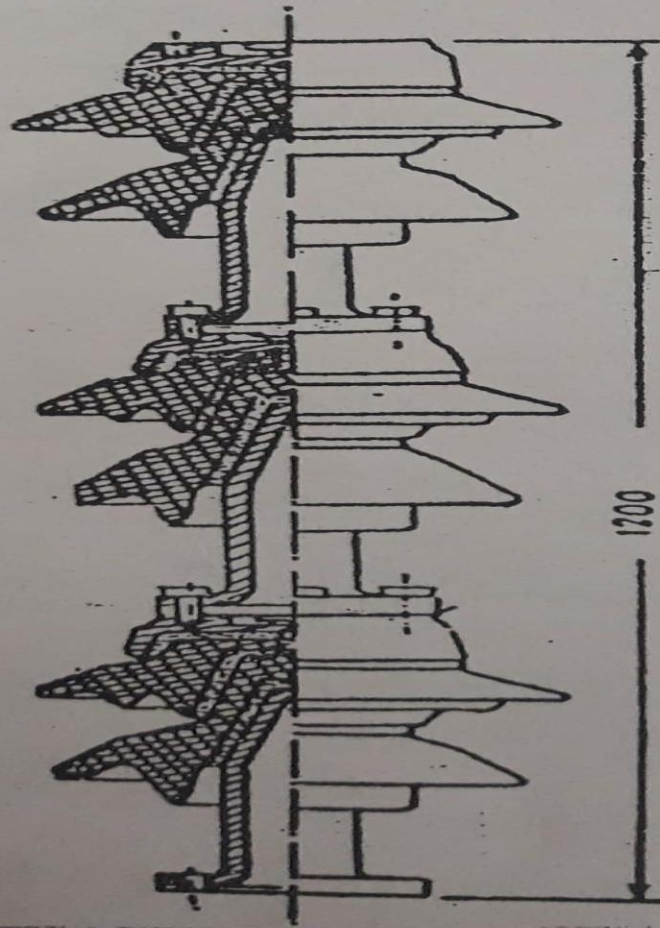

Fig.: COLUMN OF PIN  
POST INSULATOR FOR  
110-KV





# Bushings or Entrance Insulators

- ❖ An Entrance Insulator consists of a current carrying rod, flange with the help of which the insulator is fastened to the walls of a building or to the body which at not very high voltages can be simple cylinder of a dielectric having the necessary electric and mechanical strengths.
- ❖ At voltages of more than 35kV, the insulating body becomes considerably complicated in which, as a rule, liquid and solid dielectrics are combined.



# Bushings or Entrance Insulators

- ❖ Bushings in spite of its small diameter would be very inconvenient since, because of a large increase in length, it would in-justifiably increase the dimensions of an apparatus in which it is used .
- ❖ The entrance insulators in which regulation of electric field with the help of facings is obtained are called condenser type bushings.



# Bushings or Entrance Insulators

- ❖ Station and Bushing insulators are principally similar in arrangement.
- ❖ Transformer bushings experience additional heating since, during the working of transformers, temperature can be up-to 70 degree centigrade.
- ❖ Circuit Breaker bushings are subject to considerable mechanical impact loads.



# Bushings or Entrance Insulators

Fig: OIL-BARRIER BUSHING FOR 110KV

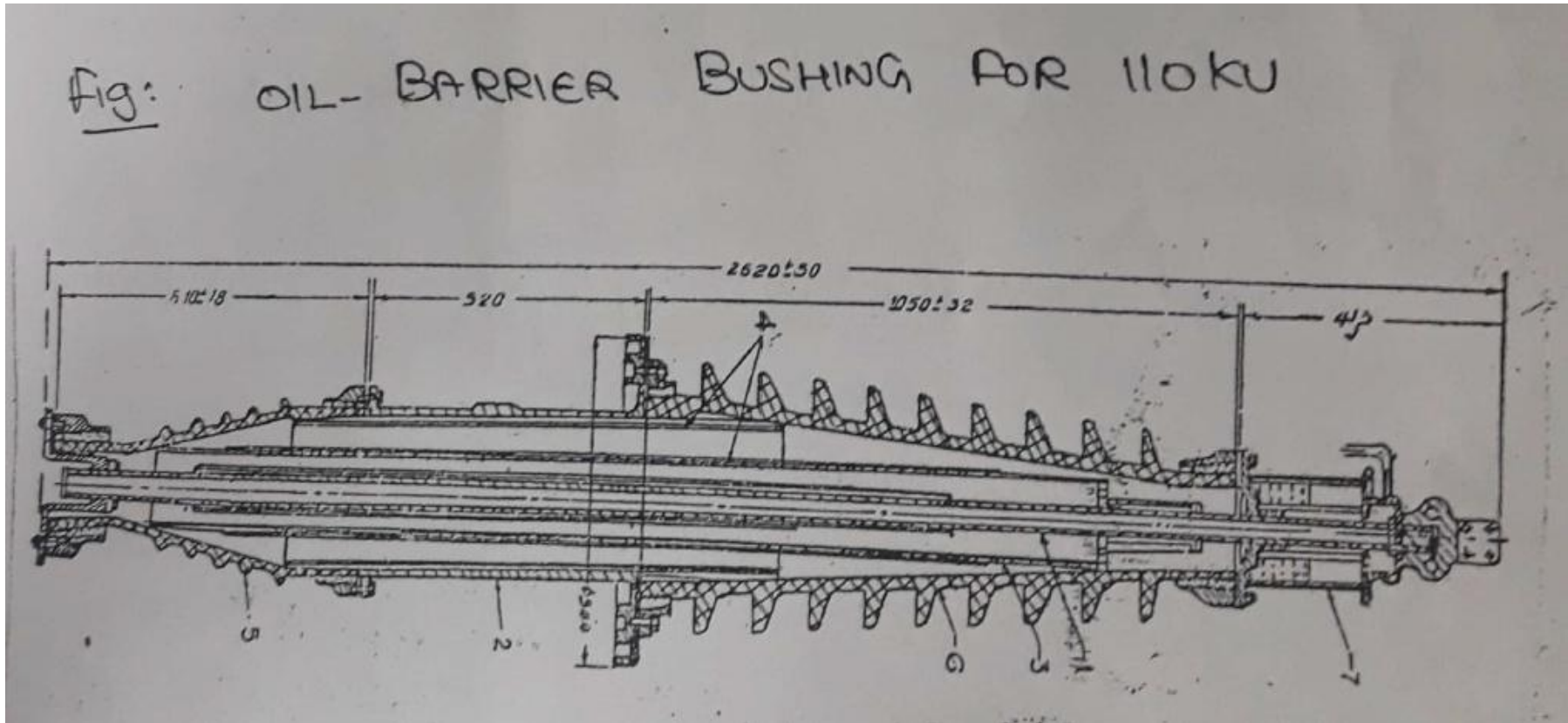

# Bushings or Entrance Insulators

## Paper oil Bushing for 150kV

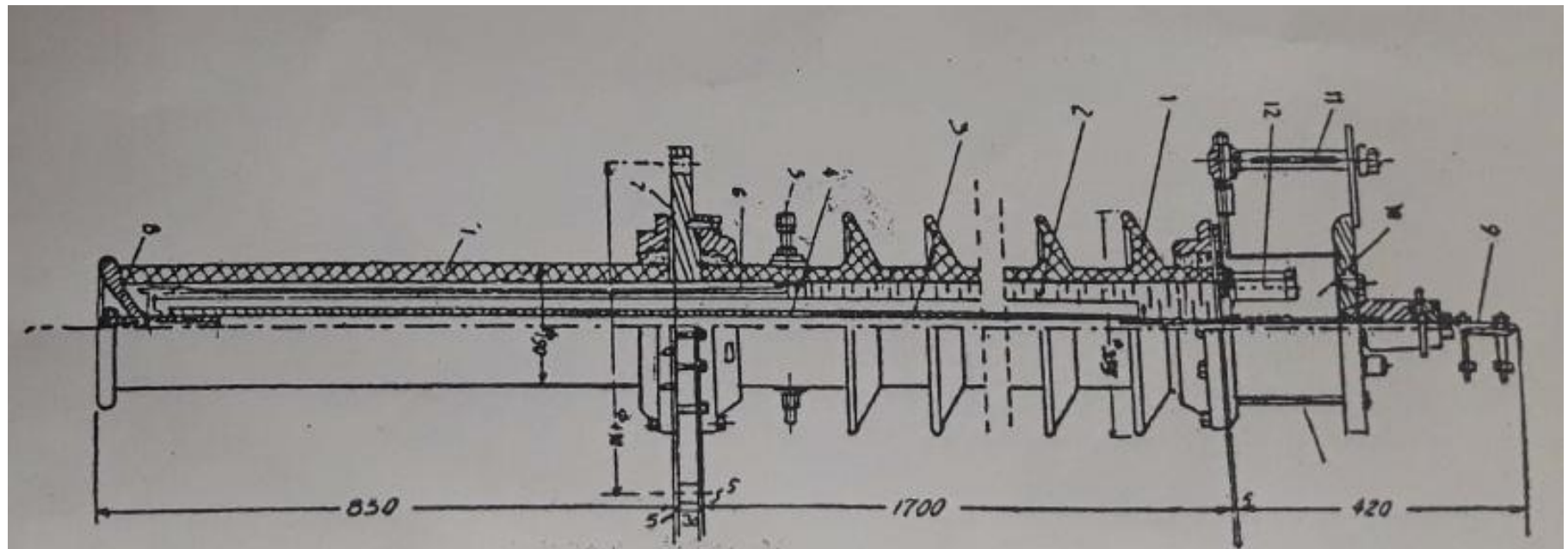

Fig. 12 22. Paper-oil bushing for 150 KV.

1—porcelain covering ; 2—oil ; 3—core ; 4—current carrying tube ; 5—oil drainage equipment ; 6—insulating tube ; 7—flange ; 8—stopper ; 9—terminal ; 10—oil expansion chamber ; 11—oil indicator ; 12—moisture absorber.



# Types:

- ❖ For a voltage of 35kV, only station type bushings are manufactured.
- ❖ Paper Bakelite condenser bushings which are compact & electrically and mechanically strong are widely used up-to 35kV.
- ❖ Oil barrier internal insulation is used for power & testing transformers up-to 110kV.
- ❖ Oil barrier insulator bushings are also used from 110 – 440kV.



- **India to Build Longest 800kV UHVDC Transmission Line**
  - New link across over 1,800 km will be capable of bringing electricity to more than 80 million people



# Insulation of Distribution Equipments

❖ Two major types:

✓ Internal Insulation (or Indoor Insulators)

✓ External Insulation (or Outdoor Insulators)





# Internal Insulation

- ❖ Main feature is practically complete freedom of its electric strength from the external atmospheric conditions.
- ❖ Here the solid dielectric or the liquid is the insulating medium and the electric strength is determined by a puncture of the gaps in this medium or by the flashover in the liquid dielectric along the insulating surfaces.
- ❖ Eg., Insulation of transformer winding for the tank and the core, insulation between windings of different voltages, insulation of coils and turns of the windings, insulation of the current carrying part of a O.C.B from the walls of its tanks etc.,.



# External Insulation

- ❖ Here the insulating medium is atmospheric air and the dielectric strength is determined by the breakdown of gases or flashover in air along the insulating surfaces and is called external insulation.

eg., surface of bushings situated in air

- ❖ Dependence of its electric strength on atmospheric conditions like temperature, pressure, humidity etc., are the distinguishing features.



# Note:

- ❖ Because of different characteristics of the insulation and different effect of atmospheric conditions on its electric strength, test voltages are separately normalised for internal and external insulations.



500kV line using composite insulators (left)  
and  
a 230 kV line using cap and pin porcelain insulators (right)



# Uses of Outdoor Insulators

- ❖ Insulators used on overhead lines are called line insulators.
- ❖ Insulators used in stations for supporting bus work and related switchgear are referred to as station insulators. They are used as bushings in apparatus in order to enable connection of the enclosed energized terminals to the overhead system.
- ❖ Station insulators are used as external housings on measuring devices such as instrument transformers, and protective equipment, i.e., surge arresters. In underground networks, they are used as terminations, which performs the transition of the overhead line to the underground line.



# Uses of Outdoor Insulators

- ❖ Line Insulators are called by several names, depending on the function.
- ❖ Insulators used on structures where the lines terminate or originate, or where the direction of the line changes, are known as dead – end insulators / tension insulators.
- ❖ Suspension and dead – end insulators are mounted on cross – arms connected to the pole. In urban areas, the right of way of transmission lines can be reduced by eliminating cross – arms and using line post insulators instead.



Photographs of dead-end (a) and station post (b) porcelain insulators, porcelain apparatus bushing (c), porcelain line post (d) and polymer cable terminations (e)

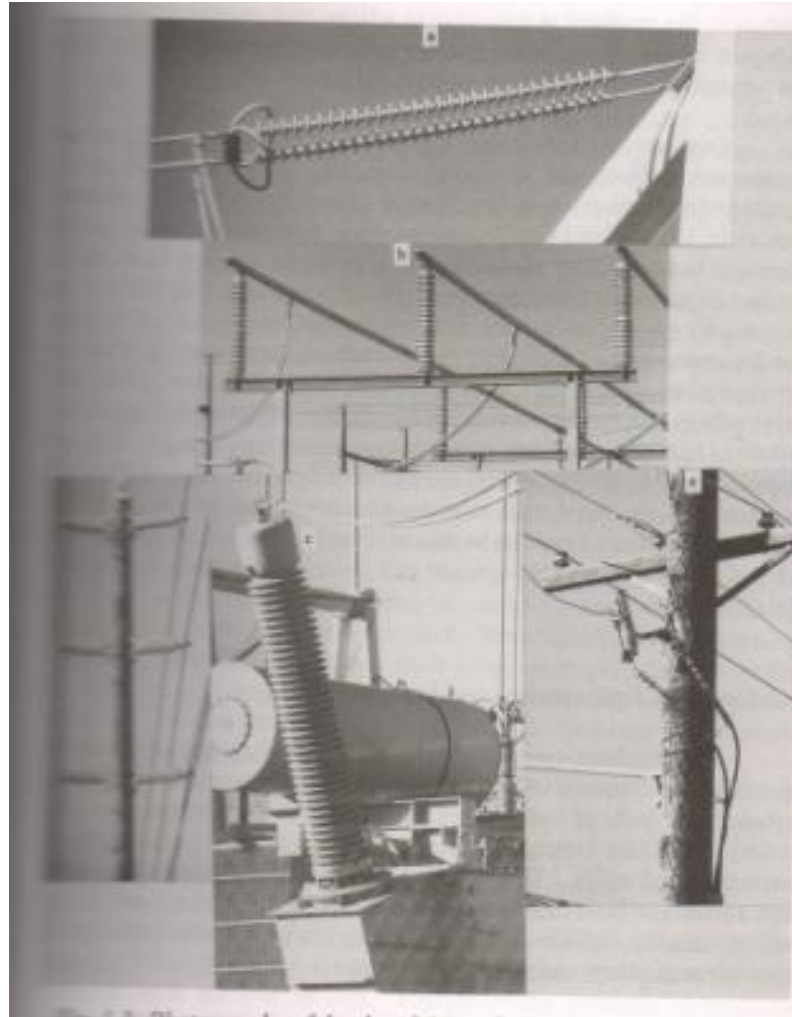





# Stresses Encountered in Service

❖ Outdoor Insulators are subjected to the following stresses:

✓ Mechanical

✓ Electrical

✓ Environmental

❖ Outdoor Insulation must withstand:

✓ Electric Fields

✓ Moisture

✓ Pollution

✓ Solar UV

✓ Discharges

✓ Surface arcs



# Stresses Encountered in Service

- ❖ The above mentioned stresses act in unison. The exact nature and magnitude of these stresses depend and vary on:
  - ✓ Insulator Design
  - ✓ Application
  - ✓ Location
- ❖ Eg., suspension and dead end insulators encounter a tensile load due to the weight and tension of the conductor. (Wind and Ice imposes additional loading)
- ❖ Whereas insulators used in supporting station apparatus encounter a compressive mechanical load.



# Stresses Encountered in Service

- ❖ Line post insulators are *subjected to a cantilever or bending load* in supporting the conductor.
- ❖ These are the loads to be expected in the steady state conditions
- ❖ In addition transient loading such as, the below mentioned too has to be considered:
  - ✓ Torsional or twisting type of loading (during line construction)
  - ✓ Vibrational loading (due to conductor vibration and movement)
  - ✓ Shock or impact loading (possible due to earthquakes, ice shedding, due to impact of vehicles on poles and vandalism)



# Stresses Encountered in Service

- ❖ Electrical stresses include the steady state stress imposed by power frequency nominal operating voltage.
- ❖ Voltage surges generated by lightning or switching operations impose a higher, but a momentary, stress on the insulator.
- ❖ In the event of an insulator flashover, the insulator is subjected to a large fault current (several kA) at power frequency , in the form of an arc called power arc.



# Stresses Encountered in Service

- ❖ The outdoor environmental conditions that which affect the insulating properties are:
  - ✓ Temperature (affects all materials)
  - ✓ UV radiation (In polymers made of organic materials, it may cause breaking of chemical bonds, and / or cross – linking on the surface).
  - ✓ Moisture in any form (rain, dew, fog, melting ice and snow) lowers Surface insulation resistance.
  - ✓ Contamination (pollution, salt deposits etc.,) reduces surface resistance.
  - ✓ Elevation above sea level (higher altitudes reduce air density and hence weakening of surface insulation strength)



# Electrical Performance

- ❖ The insulators' dielectric material is the important part which determines the electrical performance of the entire insulator structure .
- ❖ The Dielectric strength should be viewed separately as
  - ✓ Bulk or volume properties
  - ✓ Surface Properties
- ❖ The volume dielectric strength is determined by defects in the form of impurities and voids. These defects provide sites for electrical stress concentration which could lead to the formation of a permanent failure path within the dielectric.



# Electrical Performance

- ❖ Failures along the bulk of the material are permanent in nature and are called punctures.
- ❖ The surface dielectric strength is determined largely by surface deposits and moisture.
- ❖ Resistivity values, which are indicative of the dielectric strength, are typically  $> 10^{10} \Omega / \text{square}$  for the bulk material.
- ❖ This high surface resistance is maintained in dry conditions but lost in the presence of humidity and further lowered in the presence of ionic contaminants on the surface.



# Electrical Performance - Flashover





# Electrical Performance

- ❖ Failure via surrounding air medium (in case of absence of large voids or impurities in bulk) is called flashover and the electric stress required for the same is much less compared to that of bulk failure.
- ❖ The arc produced by the flashover is usually away from the surface of the dielectric.
- ❖ Whether an insulator fails by surface flashover or puncture depends on
  - ❖ the magnitude and duration of the electric stress applied
  - ❖ Insulator dimensions and
  - ❖ Defects in the material.



# Electrical Performance

- ❖ Puncture breakdown will take place at the point where the voltage – time curve of surface flashover intersects that of internal breakdown, as shown below.
- ❖ Breakdown requires the formation of an ionized channel and this channel has to be established within the duration of the applied voltage.
- ❖ If the insulator is defective, puncture can be caused by extremely short duration, large magnitude pulses.
- ❖ Lightning surges which have a rise time in the microsecond range, do not cause puncture if the insulator is sound.



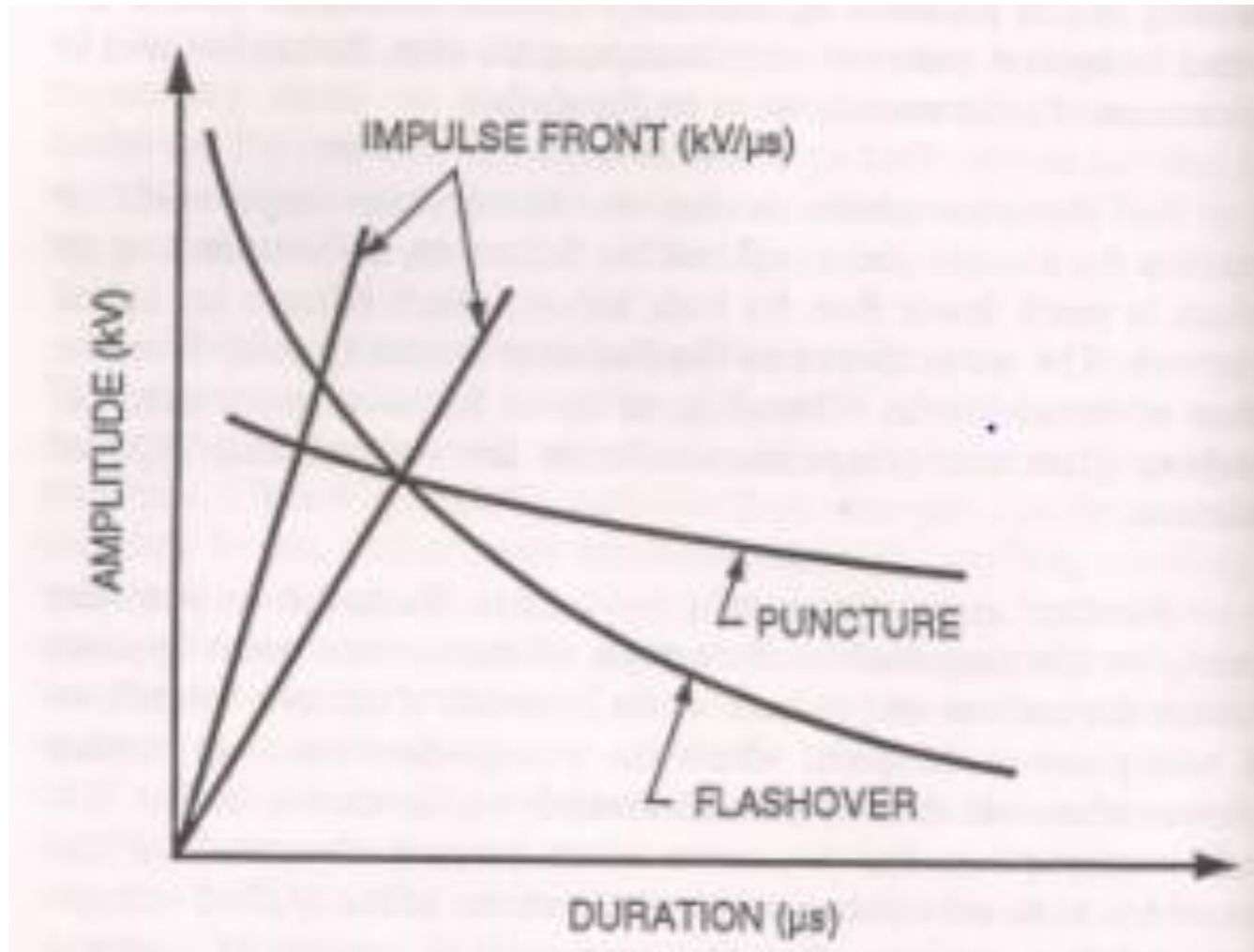

# Electrical Performance

- ❖ Similarly, switching surges normally do not cause puncture.
- ❖ Both lightning and switching surges can cause flashover if they have ADEQUATE MAGNITUDE even under dry conditions.
- ❖ Longer duration stresses such as imposed by power frequency, do not result in a puncture. A flashover is possible, however, in a wet and contaminated environment.



# Mechanical Performance

- ❖ The mechanical performance of an outdoor insulator is determined by all the main components of the insulator, including the,
  - ✓ Dielectric
  - ✓ End fittings
  - ✓ Details of internal attachment of the dielectric with the end fittings.
  
- ❖ Failure of the insulator to perform mechanically results in dropping of the conductors.
  
- ❖ This type of insulator failure is not acceptable as it leads to
  - ❖ a prolonged interruption in power,
  - ❖ possibly injury and
  - ❖ Damage.



# Role of insulators in overall Power System Reliability

- ❖ Power system apparatus are subjected to faults from
  - ✓ Man made causes
  - ✓ Natural Causes
- ❖ In a system that uses many types of apparatus, whose cost vary widely, it is important that expensive apparatus are protected from faults, even at the expense of a cheaper device.
- ❖ For eg., line insulators are cheaper than a transformer or circuit breaker in a station and hence logical that the line insulator should fail first during over-voltages.



# Role of insulators in overall Power System Reliability

- ❖ When insulator fails, it is required that the failure mode be a flashover rather than a puncture.
  
- ❖ Voltage surges produced by lightning and/or switching operations are a major factor to be considered in the electrical design of the insulator.
  
- ❖ Insulators should be designed such that,
  - ✓ They don't fail at surge voltage magnitudes that are lower than the value for which the power system apparatus have been designed.
  - ✓ For higher magnitude, the insulator should flashover.



# Role of insulators in overall Power System Reliability

- ❖ The determining values of these surges is defined by the Basic Lightning Impulse Level (BIL) and Basic Switching Impulse Insulation Level (BSL).
- ❖ Insulator design for voltages of 230 kV and below is largely dependent on lightning produced surges, whereas for 345 kV and above, it is dependent on switching surges.
- ❖ Regardless of the voltage class, in locations where contamination is a serious problem, insulator design is determined by the required contamination performance.
- ❖ Flashovers usually cause momentary interruption of power flow in the circuit.





# Role of insulators in overall Power System Reliability

- ❖ It may or may not cause customer interruption, depending on system configuration.
- ❖ Such interruptions, can be tolerated in rural locations, but not so in areas with high tech industries and hospitals.
- ❖ Flashovers can cause the insulators to be damaged thereby threatening future performance.
- ❖ The degree of damage depends on the
  - ✓ Type of insulator, and the
  - ✓ Magnitude and duration of the fault.



# Different degrees of damage to a porcelain insulator due to flashover; (top) glaze damage and (bottom) fracture of dielectric shell

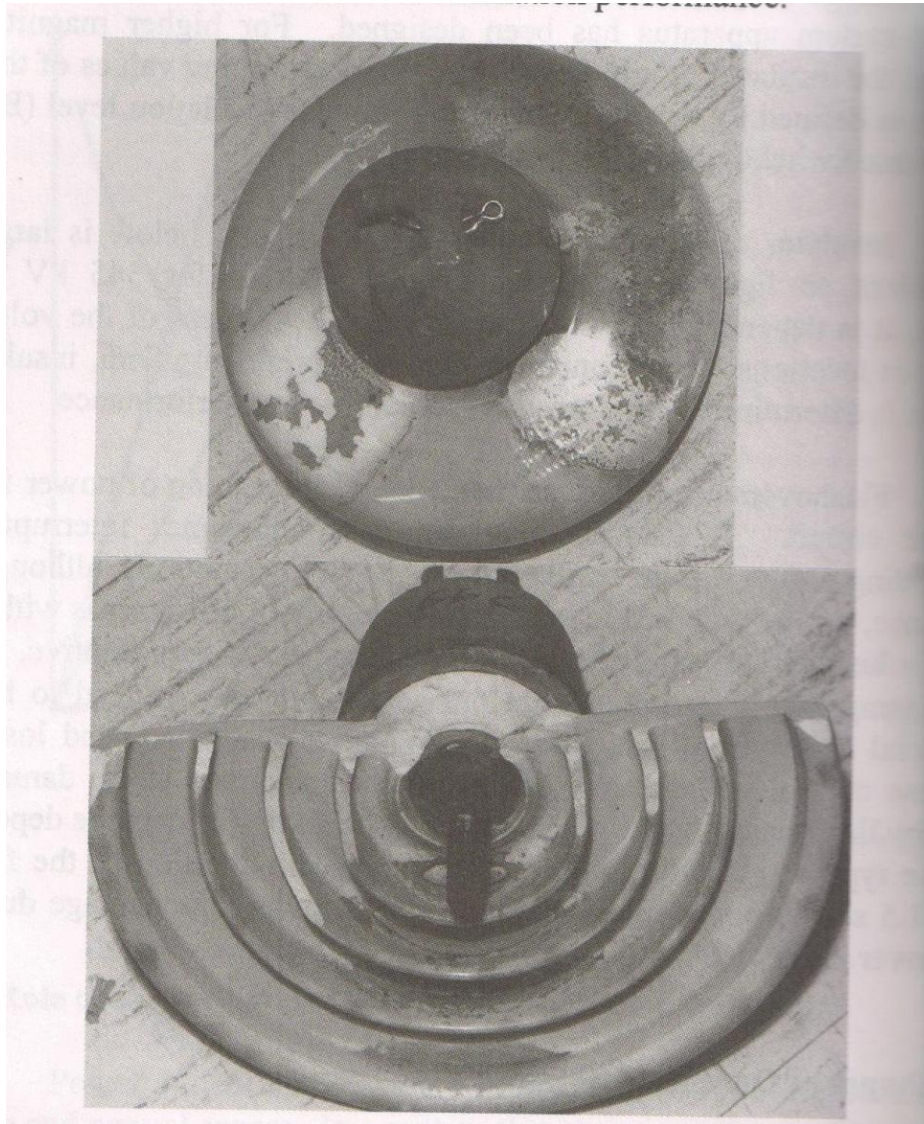

# Shapes of outdoor insulators

- ❖ Flashover due to surges is determined by the shortest spacing in air between the electrodes of an insulator.
- ❖ This spacing is called the dry arcing Distance.
- ❖ Moisture has little effect on the flash over voltage due to lightning surges.
- ❖ The flashover voltage under surge is however dependent on the dry arcing distance.



# Shapes of outdoor insulators

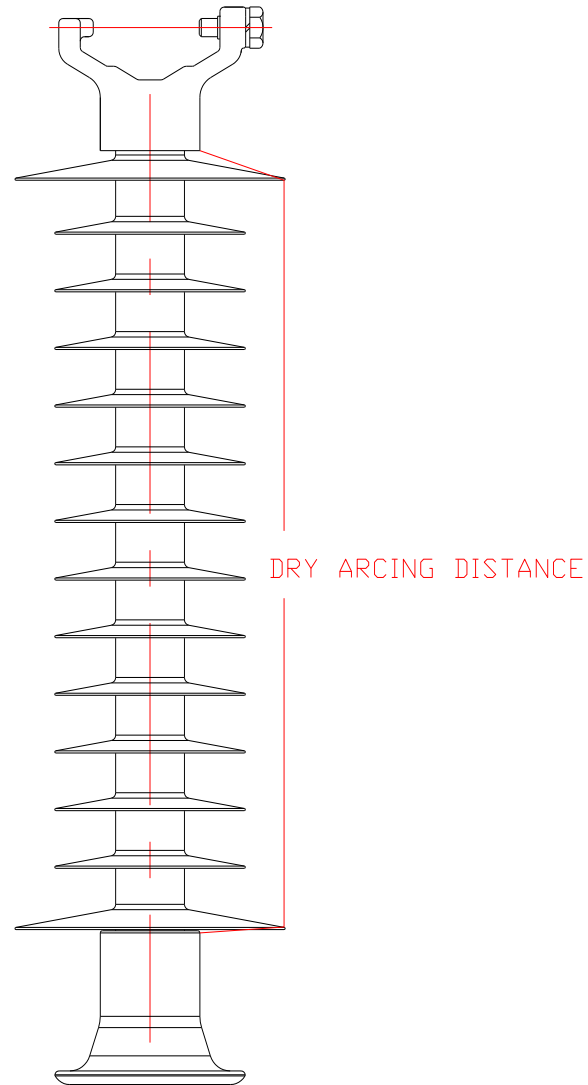

# Shapes of outdoor insulators

- ❖ Flashover under contaminated conditions is depending on the leakage or Creepage distance.
- ❖ If the dielectric material is not altered during service, electrical characteristics like power frequency wet withstand or flashover, lightning and switching surges, are defined by the arcing distance.
- ❖ The shape or profile of the dielectric determines the leakage distance and is important for the insulator's contamination performance.
- ❖ In order to increase the leakage distance, and to help keep certain parts of the insulator dry it is common to see corrugations on the underside of porcelain and glass cap and pin insulators





Profiles of porcelain and glass insulator. Standard (A), fog type (c) and aerodynamic (H) are commonly used

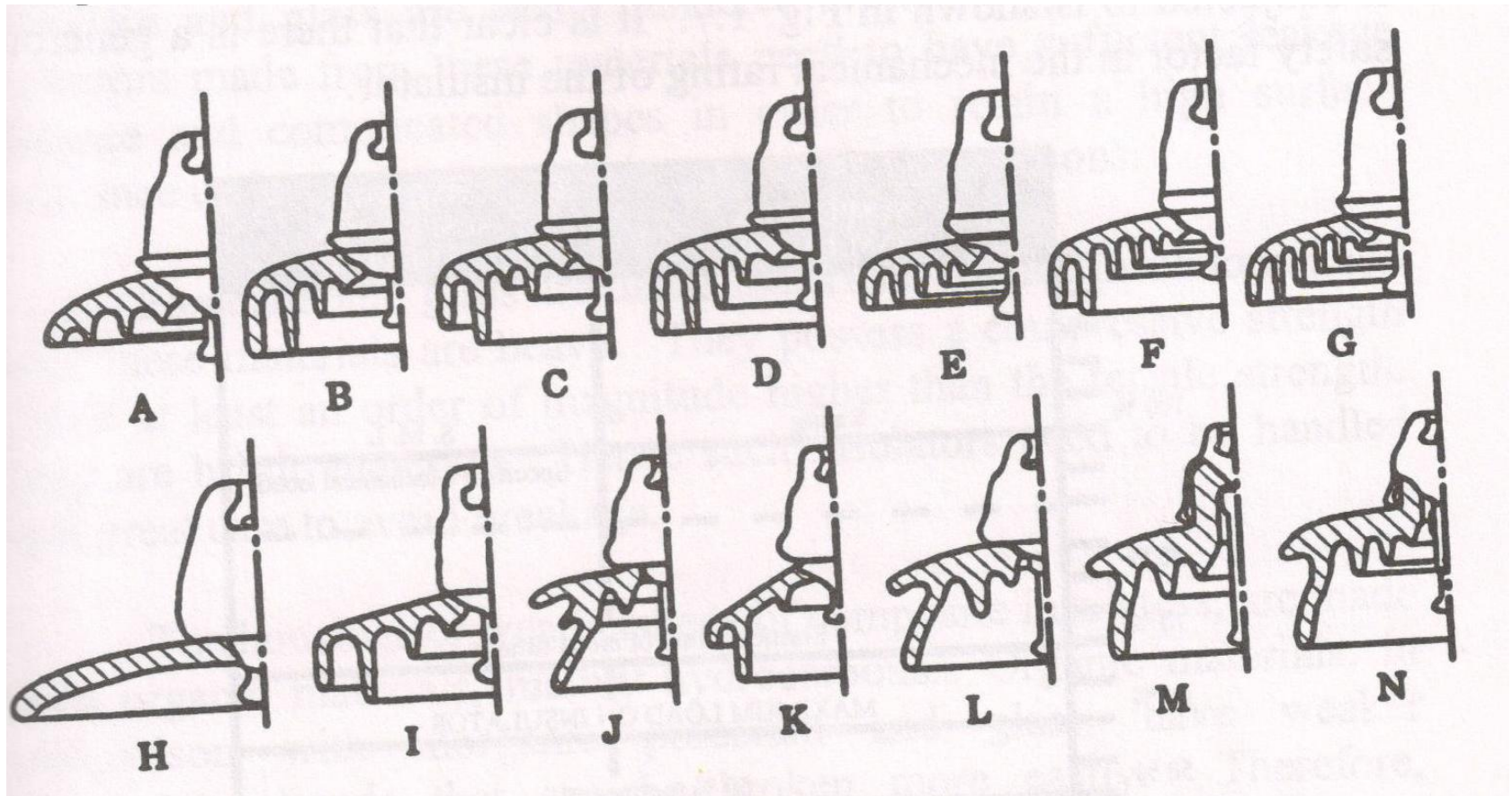

# Shapes of outdoor insulators

- ❖ Many shapes of porcelain and glass insulators have been developed as shown above, of which common ones are (A – standard), (C – fog type) and (H-Aerodynamic).
- ❖ For composite insulators, as there are no intermediate electrodes, the required leakage distance can be obtained with relatively simple shapes.
- ❖ The long rod porcelain insulator, also has a simple shape with no corrugations or under-ribs.



# Mechanical and Electrical Ratings of Insulators

- ❖ Since insulators perform both mechanical and electrical functions, they are identified by a combined mechanical and electrical rating ( M and E rating).
- ❖ The M and E rating is defined as the mechanical load at which insulator fails to perform its function either electrically or mechanically, when voltage and stress are applied simultaneously.
- ❖ It is normal to design the insulator such that the daily and maximum loads experienced by the insulator do not exceed 20 % and 50 % of the M and E rating, respectively.
- ❖ International standards require that every suspension insulator unit be routinely tested with a 50% (per American National Standards Institute – ANSI) or 60% (per IEC) of the M and E rating for 10 seconds.





# Schematic showing relationship of M and E/SML rating with, daily, maximum and routine test loads

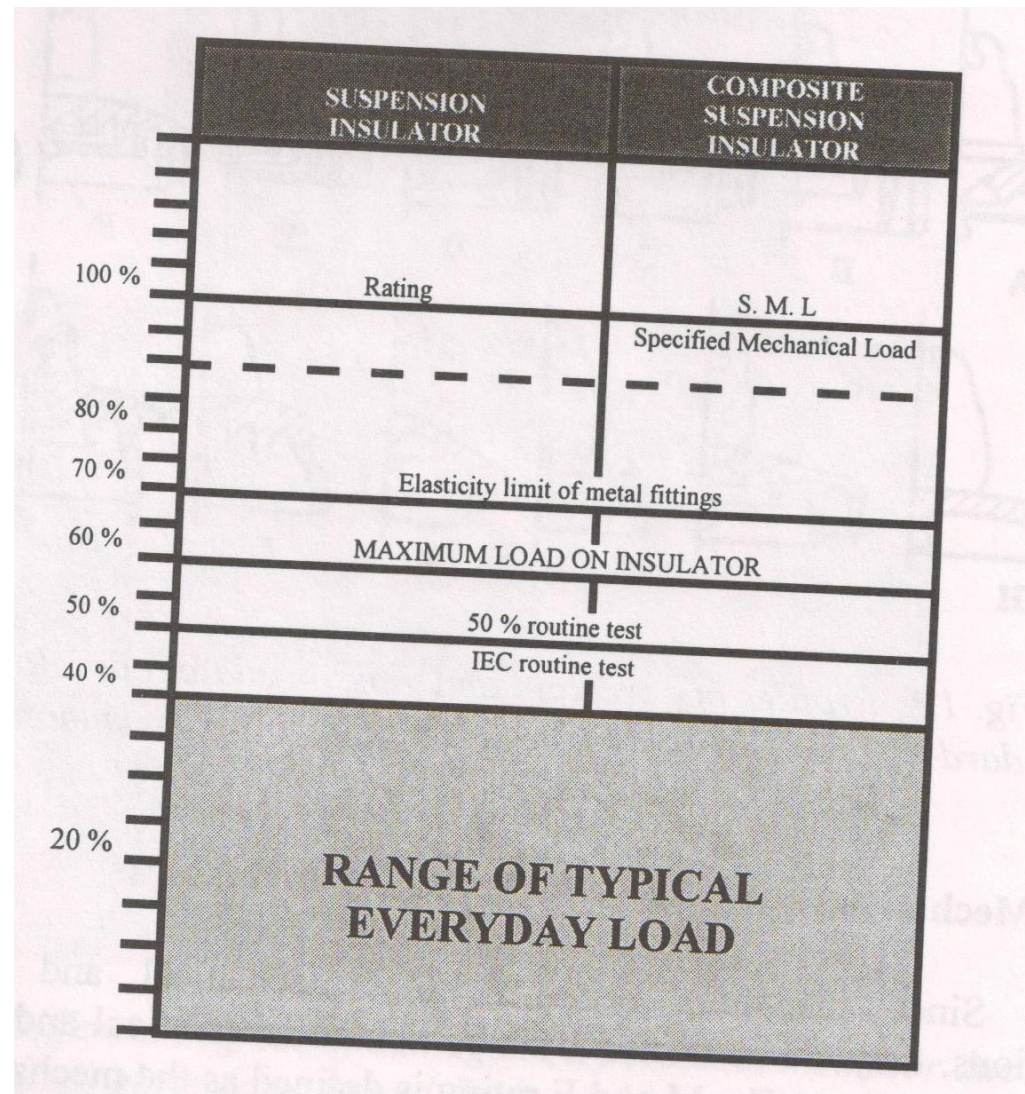

# Mechanical and Electrical Ratings of Insulators

- ❖ Composite insulators are rated by their Specific Mechanical Load (SML), which is defined as the tensile load specified by the manufacturer that has to be verified during mechanical load test.
- ❖ International standard require that every suspension insulator unit is routinely tested with a 50% M and E rated load for 10 seconds.
- ❖ The relationship between the M and E rating or SML rating of insulators, everyday load, maximum load and routine test load that every insulator is subjected to is shown in the previous slide.
- ❖ It is clear that there is a generous safety factor in the mechanical rating of the insulator.



# Comparison of outdoor insulators

## Insulator Types - Comparisons

### Ceramic

- ❖ Porcelain or toughened glass
- ❖ Metal components fixed with cement
- ❖ ANSI Standards C29.1 through C29.10

### Non Ceramic

- ❖ Typically fiberglass rod with rubber (EPDM or Silicone) sheath and weather sheds
- ❖ HDPE line insulator applications
- ❖ Cyclo-aliphatic (epoxies) station applications, some line applications
- ❖ Metal components normally crimped
- ❖ ANSI Standards C29.11 – C29.19



# Comparison of outdoor insulators

## Insulator Types - Comparisons

### Ceramic

- ❖ Materials very resistant to UV, contaminant degradation, electric field degradation
- ❖ Materials strong in compression, weaker in tension
- ❖ High modulus of elasticity – stiff
- ❖ Brittle, require more careful handling
- ❖ Heavier than NCI

### Non Ceramic

- ❖ Hydrophobic materials improve contamination performance
- ❖ Strong in tension, weaker in compression
- ❖ Deflection under load can be an issue
- ❖ Lighter – easier to handle
- ❖ Electric field stresses must be considered



# Comparison of outdoor insulators

## Insulator Types - Comparisons

### Ceramic

- ❖ Generally designs are “mature”
- ❖ Limited flexibility of dimensions
- ❖ Process limitations on sizes and shapes
- ❖ Applications/handling methods generally well understood

### Non Ceramic

- ❖ “Material properties have been improved – UV resistance much improved for example
- ❖ Standardized product lines now exist
- ❖ Balancing act - leakage distance/field stress – take advantage of hydrophobicity
- ❖ Application parameters still being developed
- ❖ Line design implications (lighter weight, improved shock resistance)



# Comparison of outdoor insulators

Parameters	Porcelain	Glass	Composite
<b>Material</b>	Inorganic (resists degradation from natural elements for many years)	Inorganic (resists degradation from natural elements for many years)	Organic (more easily prone to deterioration by heat from electrical discharge activity, chemicals and natural elements like sunlight, humidity, temperature etc.,.)
<b>Melting point</b>	Excess of 1500 ° C	Excess of 1500 ° C	-
<b>Chemical Reaction</b>	Inert to most Chemicals	Inert to most Chemicals	Organic, hence more affected by chemicals
	❖ Therefore, porcelain and glass insulators are known to possess extremely high resistance to heat from electrical discharge activity in the form of arcs, corona and chemicals encountered during service.		



# Comparison of outdoor insulators

Parameters	Porcelain	Glass	Composite
Chemical Reaction	Inert to most Chemicals	Inert to most Chemicals	
	<p>❖ Their high stability is related to the <u>strong electrostatic bonds</u> between the various atoms in the material.</p> <p>❖ This attribute also imparts <u>a high value surface free energy</u>, a thermodynamic quantity that determines the strength of adhesion of the surface with water.</p> <p>❖ Hence insulators made from these materials <u>need to have sufficient leakage distance</u> and complicated shapes in order to retain a high surface resistance under wet and contaminated ambient conditions.</p>		<p>❖ <u>Weak electrostatic bonds.</u></p> <p>❖ Hence <u>lower surface free energy.</u></p> <p>❖ <u>Hydrophobic</u></p> <p>❖ <u>Increased surface resistance under wet and contaminated conditions</u></p>



# Comparison of outdoor insulators

Parameters	Porcelain	Glass	Composite
<b>Density</b>	<u>Dense</u> material And hence <u>Heavy</u>	<u>Dense</u> material And hence <u>Heavy</u>	<u>Lighter</u>
<b>Strength</b>	Possess a compressive strength that is at least an order of magnitude higher than the tensile strength.		
	They are brittle materials		Non brittle materials





# Comparison of outdoor insulators

- ❖ Ageing is the term used to describe irreversible permanent changes.
- ❖ All materials undergo ageing, albeit at different rates.
- ❖ As organic materials are more susceptible to changes from the environment and applied stress it is more common to talk of ageing with composite insulators than it is with porcelain and glass insulators.
- ❖ However, it should be mentioned that even porcelain and glass insulators are subjected to ageing.
- ❖ When chemical bonds in hydrocarbons are broken, free carbon is generated, which is conducting even in dry state.



# Comparison of outdoor insulators

- ❖ The formation of a carbonaceous conducting path on the surface of composite materials is called Tracking.
- ❖ Materials can be formulated such that the carbon is physically dislodged from the surface or removed in the form of gaseous products.
- ❖ Such modes of carbon removal will lead to a loss of material and is termed erosion.
- ❖ Hence, the “Resistance to Tracking and Erosion” of materials is an extremely important aspect of composite insulators.



# Tit kat - some HVDC projs. Of interest

NAME	CONVERTER STATION 1	CONVERTER STATION 2	LENGTH (CABLE / POLE) KM	VOLT (kV)	POWER (MW)	YEAR	REMARKS
orth-East Agra	India - Agra <a href="#">27°05'01"N78°04'22"E</a>	India - Biswanath	1728 (0/1728)	800	6000	2016	Will supply electricity to serve 90 million people Bi-pole Ultra high voltage, multi terminal (intermediate converter station at Alipurdauar) Supplier: <a href="#">ABB</a>
Champa- Kurukshetra	India - Champa	India - Kurukshetra	1365 (0/1365)	800	2 x 3000	2016	2 Bipoles. Supplier: <a href="#">Alstom</a>



# Tit kat - some HVDC projs. Of interest

<a href="#">Talcher-Kolar</a>	India - Talcher, Odisha <a href="#">21°06'01"N85°03'49"E</a>	India - Kolar, Karnataka <a href="#">13°10'39"N78°7'0"E</a>	1450 (0/1450)	500	2500	2003	Supplier: <a href="#">Siemens</a>
<a href="#">Chandrapur-Padghe</a>	India - Chandrapur <a href="#">20°0'36"N79°17'06"E</a>	India - Padghe <a href="#">19°21'26"N73°11'18"E</a>	752 (0/752)	500	1500	1999	Supplier: <a href="#">ABB</a>
<a href="#">Rihand-Delhi</a>	India - Rihand <a href="#">24°01'13"N82°47'21"E</a>	India - Dadri <a href="#">28°35'36"N77°36'16"E</a>	814 (0/814)	500	1500	1990	Supplier: <a href="#">ABB</a> , BHEL



# Tit kat - some HVDC projs. Of interest

<a href="#">ileru-Barsoor</a>	India - Sileru <a href="#">17°52'01"N81°39'21"E</a>	India - Barsoor <a href="#">19°8'20"N81°23'47"E</a>	196 (0/196)	200	100	1989	Supplier: BHEL
Tamil Nadu	India - Raigarh	India - <a href="#">Pugalur</a>	1830	800	6000	2019	Supplier: <a href="#">ABB</a>
Ballia - Bhiwadi	India - Ballia <a href="#">26°04'16"N83°42'48"E</a>	India - Bhiwadi <a href="#">28°11'0"N76°48'58"E</a>	800 (0/800)	500	2500	2010	Supplier: <a href="#">Siemens</a>



# References

- ❖ Ravi S. Gorur, Edward A. Cherney, Jeffrey T. Burnham, “Outdoor Insulators”, Ravi S. Gorur, Inc., Phoenix, Arizona 85044, USA, 1999.
- ❖ Raja Prabu. R, Ph. D Thesis titled “Electrical Insulation Characteristics of Silicone and EPDM Polymeric Blends for Outdoor Applications”, CEG, Anna University, 2004.
- ❖ IEEE standard Techniques for “High Voltage Testing”, 1995.
- ❖ ANSI, “Composite Insulators for Overhead Transmission Lines”, 1989.



# References

- ❖ IEC, “Guide for the selection of Insulators”, 1986.
- ❖ EPRI, “Transmission Line Reference Book”, California 1982.
- ❖ J. S. T. Looms, “Insulators for High Voltages”, Peter Peregrinus, 1988.
- ❖ Reuben Hackam, “Outdoor HV Composite Polymeric Insulators”, IEEE Transactions on Dielectrics and Electrical Insulation, 1999.



# Thank You

